



Installation instructions for Pacific Vinyl Floors
in the Chevron collection.

pacificfloors.pl

Installation instructions for Pacific Vinyl Floors in the Chevron collection.

These installation instructions apply to Pacific Vinyl Floors in the Chevron collection, with a thickness of 4.5 + 1 mm, equipped with an integrated silencing pad.

Preparation

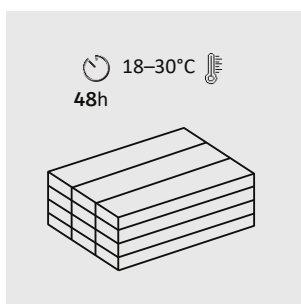

1

Store Pacific Vinyl Floors panels on a flat surface, in even piles, away from moisture and extreme temperatures (35°C). Acclimatize them for 48 hours at 18–30°C before installation at the installation site. Maintain this temperature before, during and for 24 hours after assembly. Carry out installation at an ambient temperature of 18–30°C and substrate temperature above 15°C.

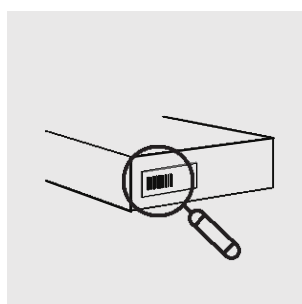

2

Pacific Vinyl Floors panels are available in a variety of forms, patterns and properties. Before installation, check that the product corresponds to your order. Keep the labels and proof of purchase.

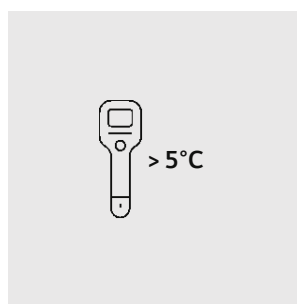

3

Pacific Vinyl Floors panels are designed for installation in heated rooms where the temperature exceeds 5°C. You will get the best results at room temperature (18–30°C). The panels are not suitable for installation in solariums, porches, caravans, boats or other unheated spaces.

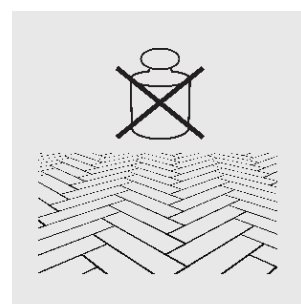

4

Pacific Vinyl Floors should not be blocked. Heavy objects such as kitchens and permanent furniture structures, should be installed before laying the floor. Heat-emitting objects, such as stoves, must be placed on protective panels, and the panels must be arranged around them, maintaining adequate expansion gaps.

The floor must be able to move freely to prevent gaps. It is required to provide adequate expansion joints around heavy structures and other objects. The panels are a floating floor and should not be permanently fixed to the subfloor.

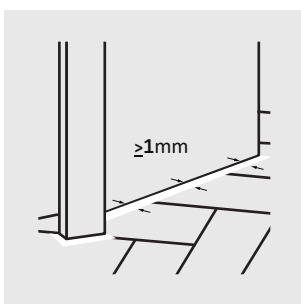

5

If the door frame is installed after the installation of the floor, ensure a gap of 1 mm between the end of the frame and the floor surface.

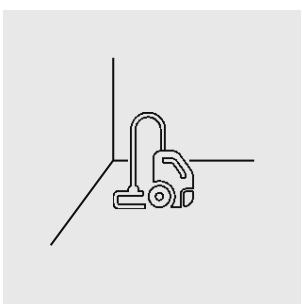

6

The substrate must be dry, even, stable, clean and free of grease. Remove old glues, sweep and vacuum, removing dirt and nails. Repair larger cracks. Remove the old wall slats before installation and install the new ones when finished.

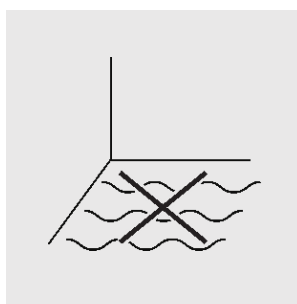

7

The quality and preparation of the substrate have a key impact on installation. If the substrate is unsuitable, consult your Pacific Vinyl Floors supplier. Uneven subfloors can lead to deformations and cracks in the floor.

>>>

The substrate should be stable and well fixed. Do not install floating floor on soft, damaged or loose substrate. Remove any soft coverings, such as carpet, rug or soft vinyl, and floating floor coverings.

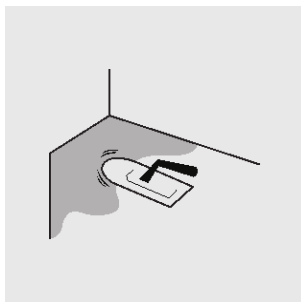

8

Cement joints and cracks with a depth of more than 2 mm and a width of more than 5 mm should be leveled.

For Pacific Vinyl Floors panels with a snap-in system: smooth out subfloor irregularities exceeding 1 mm by 20 cm and 4 mm by 2 m. Use sanding or scraping.

>>>

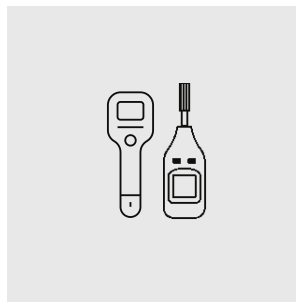

9

If a self-leveling screed is needed, check whether a primer or sealer is required..

Concrete substrates must be dry. The moisture content of the substrate must not exceed 2% in CM scale for cement and 0.5% for anhydrite.

In the case of underfloor heating, the moisture content should not exceed 1.8% on the CM scale, while for

anhydrite — 0.3% on the CM scale. Conduct humidity measurements and record the results.

>>>

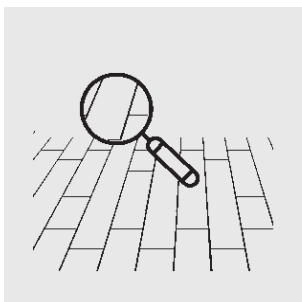

10

The wooden substrate must be level, and any loose parts must be firmly fixed. It is important to ensure adequate air circulation and venting at the edges. If the wooden substrate is damp or lacks an adequate moisture barrier underneath, the moisture must first be removed before proceeding with installation.

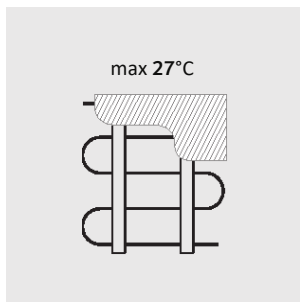

11

Interior floors with various heating systems should be separated by a transition profile and have an expansion gap of at least 8 mm wide.

Floor heating:

The maximum temperature of the floor surface should not exceed 27°C. The temperature should be changed gradually at the beginning and end of the heating season.>>>

Avoid heat accumulation through carpets or improper furniture placement.
Floor cooling:

The thermal resistance of the floor should be below 0.15 m²K/W. Use systems with condensation detection sensors that turn off cooling when condensation occurs. Panels must be properly protected with a thermal seal when underfloor heating.



12

Pacific Vinyl Floors Chevron flooring has integrated substrate, so additional substrate is not needed.

Tools:

Tools: knife, pencil, tape measure, protractor, 5-8mm expansion wedges, protective gloves, safety glasses.

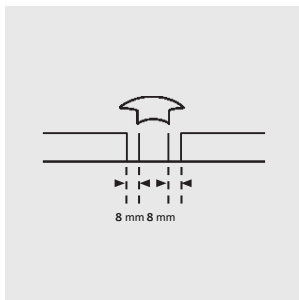

13

Wall expansion joint between panels and all elements of vertical structures (columns, walls, islands, etc.) should be min. 5 mm, and with underfloor heating min. 8 mm.

Pacific Vinyl Floors can be installed without expansion strips in rooms with an area of 200m² or less and where none of the dimensions exceed 20m. >>>

Expansion cut is required when:
a. room exceeds 20m in length;
b. room exceeds 20m in width;
c. area exceeds 200m².

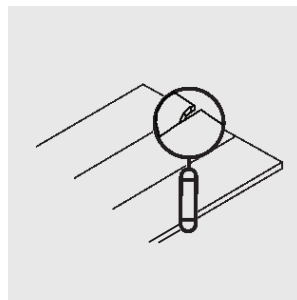

14

Before and during installation, check the panels under natural light to ensure that the color and quantity match the order, and the packaging is not damaged. Inspect each panel for defects and do not install defective ones. After installation of the panel, claims will not be accepted.

Assembly rules

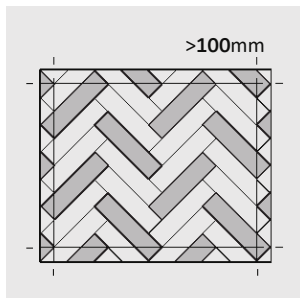

1

Before installation, measure the length and width of the room to correctly plan the layout of the floor rows. Make sure the last row is not narrower than 100 mm by moving the center line if necessary.

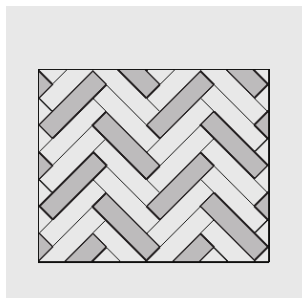

2

When installing, mix panels from different packages to avoid stacking too many boards of similar shade next to each other.

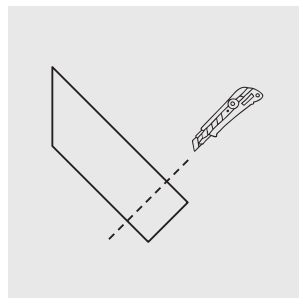

3

If you need to shorten the panel with a crosswise, straight cut, Pacific Vinyl Floors Chevron should be cut with the pattern side facing up, using a special vinyl panel cutter. To cut the panel, draw a straight line along which the cut will occur. Using a knife, cut the surface along this line. There is never a need to cut the panel completely. (Hint: integrated substrate should also better

be cut before breaking the panel.) Then break the panel along the notch with both hands. Use a saw for every other cut. Depending on the type of saw, lay the panel with the pattern side facing up or down. Before cutting, do a test on the unwanted piece to determine how to cut the panel most accurately (with the pattern side facing up or down).

>>>

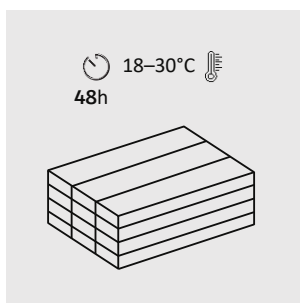

4

Installation at temperatures lower than the ones recommended makes it difficult to work with Pacific Vinyl Floors Chevron. Panels become less flexible, more difficult to cut, especially smaller pieces, which increases the risk of damage to the locks and subsequent expansion of the floor. At higher temperatures

excessive shrinkage of the panels and the appearance of gaps may occur. Pacific Vinyl Floors Chevron flooring is meant to be floating — do not nail the panels to the subfloor or glue the locks together, except to replace individual panels.

>>>

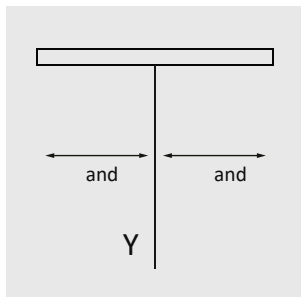

5

The herringbone pattern usually starts from the center line. Use a straight patch or string to mark the "Y" line.

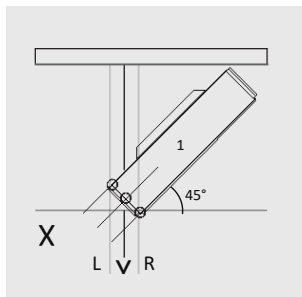

6

Place the first stave at a 45° angle. Draw additional lines "L" and "R" running parallel to the "Y" line to determine the position of the corners of the stave. Then draw an "X" line as shown. To facilitate installation, make sure that the stave feathers face away from the wall in the direction of installation.

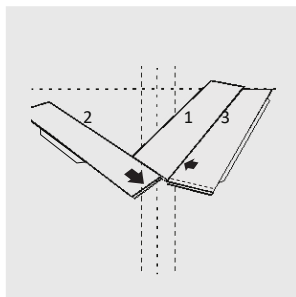

7

Place the first stave (1). Then connect the stave (3) to the first one, inserting it into the groove at an angle of about 20°, but do not lay it flat yet. Use the stave (3) to determine the position of the stave (2) during its installation. Extend the stave (3) by about 5 mm beyond the stave (1). Now insert the stave (2) at an angle into the lock of the short side of the stave (1), press against the stave (3) and lower it to a horizontal position. >>>

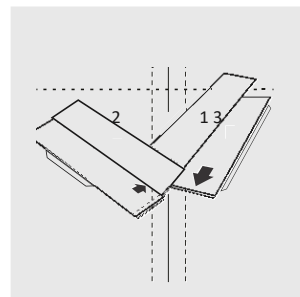

Repeat the same steps with staves (3) and (4). The stave (4) will serve as a stop when laying the stave (3). Lower the stave (3) to a horizontal position. Continue this way, assembling successive staves until the middle rows are laid out in full.

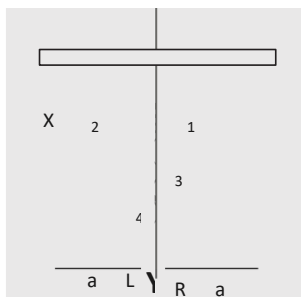

8

Make sure the locks are securely closed. Gently use a hammer and a dovetail block to ensure that the locks engage securely.

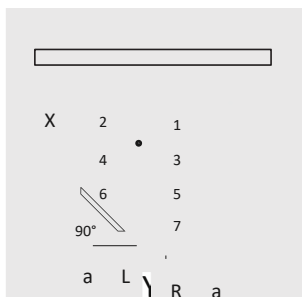

9

Continue assembly, gently tapping the staves so that the locks are fully engaged. Use a patch or line to make sure the rows are straight. Repeat these steps when assembling more rows.

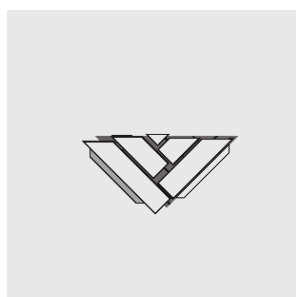

10

After arranging the staves of the middle row, fill in the triangular areas between the staves and the wall. Use spacer wedges to maintain a proper expansion gap. For stability, load the stacked rows with parcels or other weight to prevent the floor from shifting.

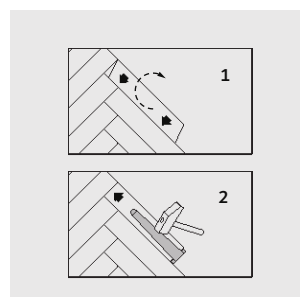

Continue the assembly according to the scheme:

- a. Connect the long side of the stave, lifting it at an angle of about 20°.
- b. Gently tap the short side flat, using a block and hammer.
- c. Check that both sides are well closed and make sure there are no gaps.

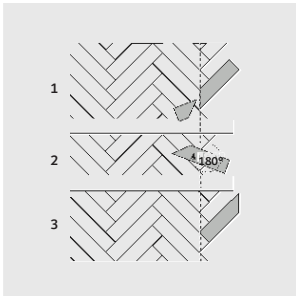

11

Lay the staves of the last row as in a normal row, then rotate them 180°, placing the corner against the wall and keeping the space for expansion joints. Determine the cut line and cut off the excess.

Turn the stave back to its original position and install it. Repeat this process for each stave.

Once the installation is complete, remove the spacer wedges, allowing the floor to expand and contract freely. >>>

Tips:

Kneeling on the installed part of the floor will help prevent the panels from moving during installation.

To make the job easier, connect the first 10 staves, kneel on them while assembling the next ones, and then press them against the wall. Install spacer wedges and check the straightness of the rows, making any corrections.

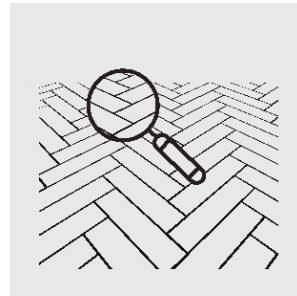

12

After installing each panel, check that all short and long sides are well connected, with no gaps or differences in height. Continue assembling more rows toward the edge of the room. It is most comfortable to work while sitting on pre-installed panels.

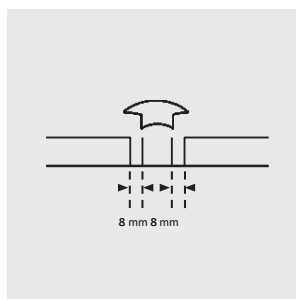

13

Wall expansion joint between panels and all elements of vertical structures (columns, walls, islands, etc.) should be min. 5 mm, and with underfloor heating min. 8 mm.

Expansion cut is required when:
a. room exceeds 20m in length;
b. room exceeds 20m in width;
c. area exceeds 200m².

Pacific Vinyl Floors can be installed without expansion strips in rooms with an area of 200m² or less and where none of the dimensions exceed 20m.

Finishing

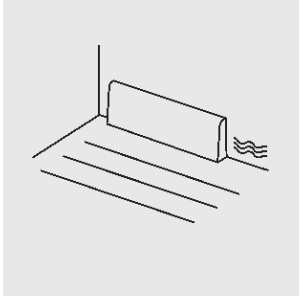

1

Mount the skirting boards against the wall, not attaching them directly to the floor. This will allow the floor to expand and contract. Do not fill expansion joints with silicone.

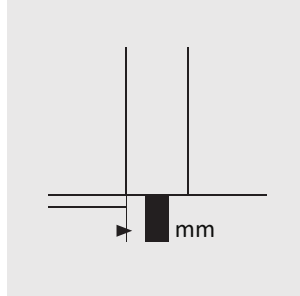

2

At thresholds and doorways, undercut the doorframe by laying the panel with the underside up and placing it against the doorframe. Use a multi-tool or hand saw to cut the frame at the correct height, keeping the expansion gap at 8 mm. Remove waste and vacuum the surface. Install the panel by sliding the short side close to the undercut frame and the long side toward the already installed panel. Use a tightening and/or tapping tool to ensure a solid connection.

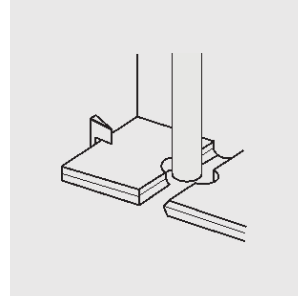

3

Lay the panels in places with pipes so that the pipe runs along the joint line between the panels. Choose a drill bit with a pipe diameter plus 16 mm. After snapping the panels on the short side, drill a hole in the middle of the panel joint. Now the panels are ready to be installed.

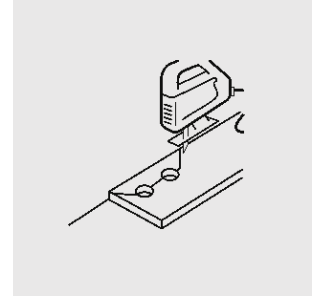

4

In rows with double pipes, follow the steps below:

- a. Determine where the pipe will pass through the panel, taking into account the additional 16 mm for the expansion gap.
- b. Drill into the panel at the designated location.
- c. Extend the opening to the edge of the panel.
- d. Mount the panel around the pipe.

Maintenance

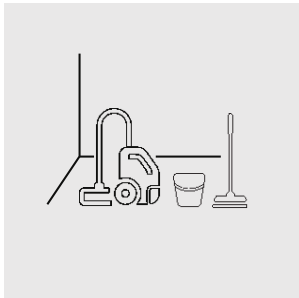

1

After the installation of Pacific Vinyl Floors Chevron is complete, you can walk on the floor right away. To preserve its appearance and extend its life, regular maintenance is key. The frequency of cleaning depends on the volume of traffic, the degree of dirt and the type of floor. Detailed information is available at www.pacificfloors.pl

For dry cleaning use a mop or vacuum cleaner

>>>

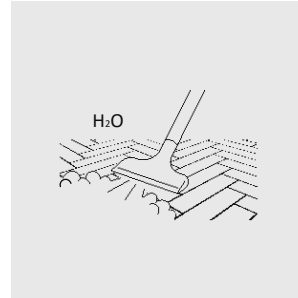

2

with soft wheels and a brush for vinyl floors to avoid scratches. Steam cleaners can be used, but be sure that the steam does not go directly to the floor surface. Use a suitable terry pad to evenly distribute heat and steam. Clean the floor along the panels and do not leave the nozzle in one place for too long.

Pacific Vinyl Floors Chevron can be cleaned with a damp mop. Use mild cleaning agents, avoiding soap, which can leave a sticky film, and agents with abrasive particles, which can tarnish the surface. Do not use too much detergent to avoid hard-to-remove residues. Improper maintenance can damage the floor. More information on cleaning is available at www.pacificfloors.pl. >>>

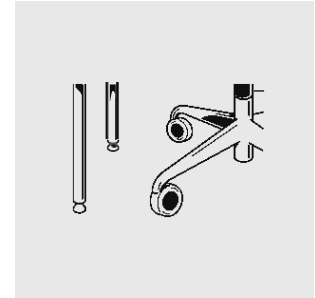

3

Legs of furniture and chairs should be secured, by using chairs with soft W-type casters or suitable pads.

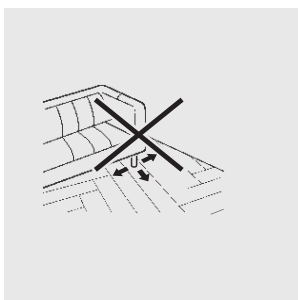

4

Moving heavy objects across the floor is prohibited; lift them. The legs of the furniture should have a large surface area and be equipped with protective caps to reduce the risk of damage to the floor. Place welcome mats at the front door to limit bringing in >>>

dirt and sand, which will reduce the need for maintenance and prolong the life of the floor. Avoid contact with rubber, latex, cigarettes, matches and other hot objects to prevent permanent discoloration and damage.

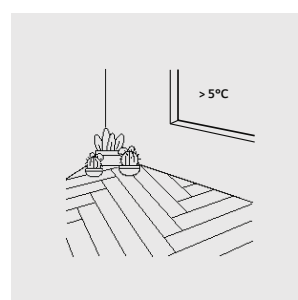

5

Make sure the indoor temperature is always above 5°C. It is recommended that the interior temperature be maintained between 18-30°C



General Distributor in Poland:
Nobless Polska, Sierosław,
ul. Skrajna 3b, 62-080 Tarnowo Podgórne

pacificfloors.pl